

DF

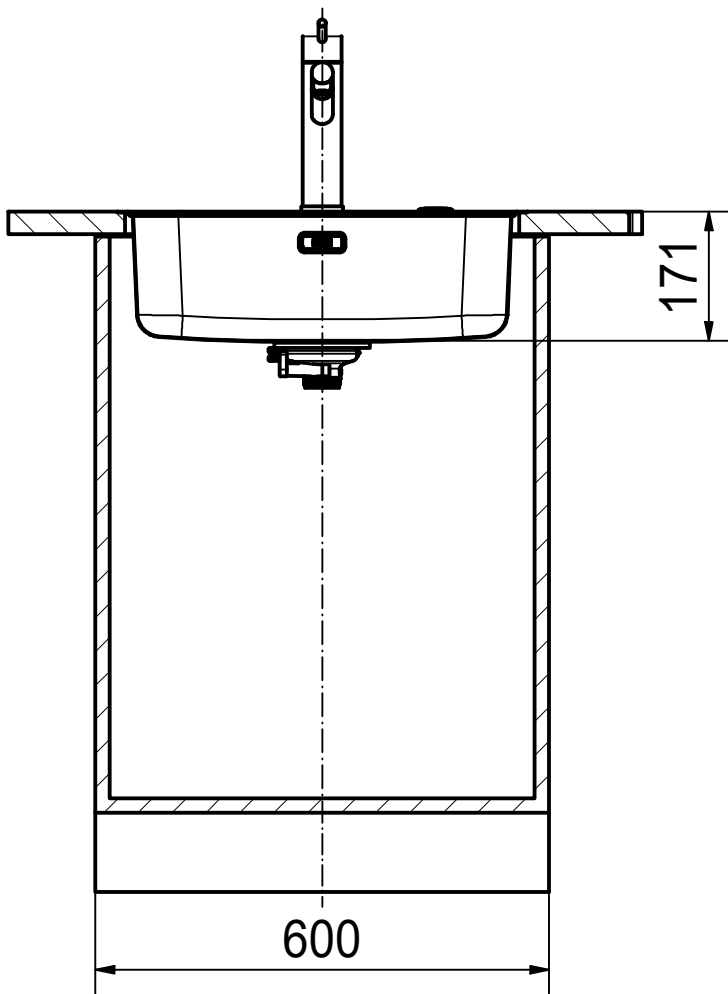

Drawing No.	20242539_01	Revision	-
Drawn Date	13.09.2022		
<small>These drawings and specifications are the property of Franke Technology and Trademark Ltd. and shall not be reproduced, copied or transferred to any third party without the prior written permission of Franke Technology and Trademark Ltd., Hergiswil, Switzerland</small>			



SRX 210-50 SI
installing document

Sheet	Sheets
1	6

DS

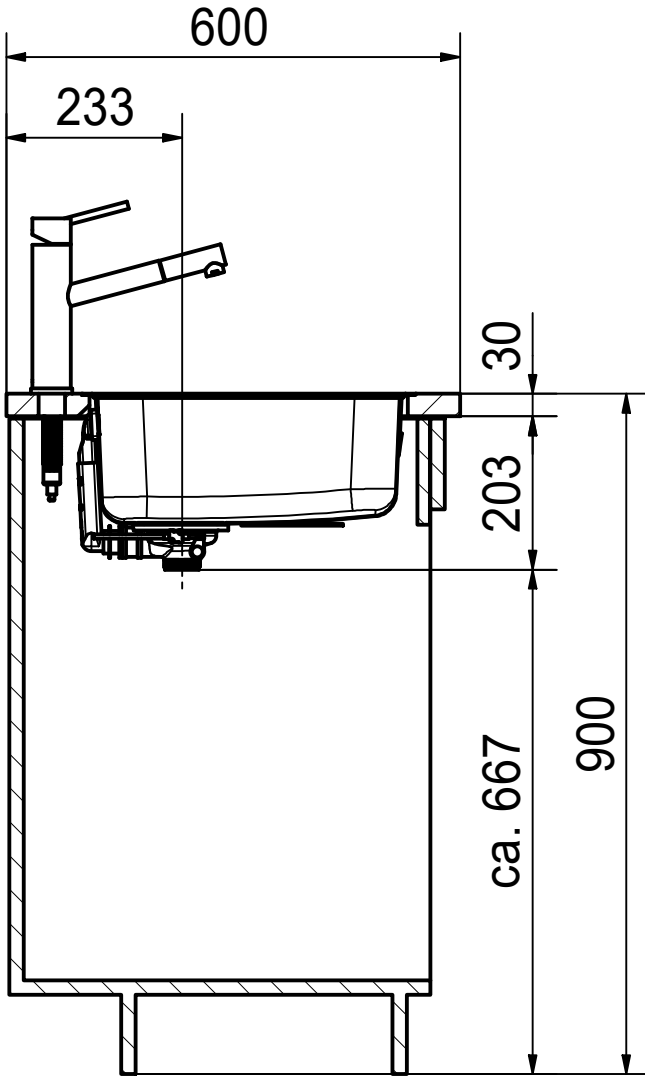

Drawing No.	20242539_01	Revision	-
Drawn Date	13.09.2022		
<small>These drawings and specifications are the property of Franke Technology and Trademark Ltd. and shall not be reproduced, copied or transferred to any third party without the prior written permission of Franke Technology and Trademark Ltd., Hergiswil, Switzerland</small>			



SRX 210-50 SI
installing document

Sheet	Sheets
2	6

CO

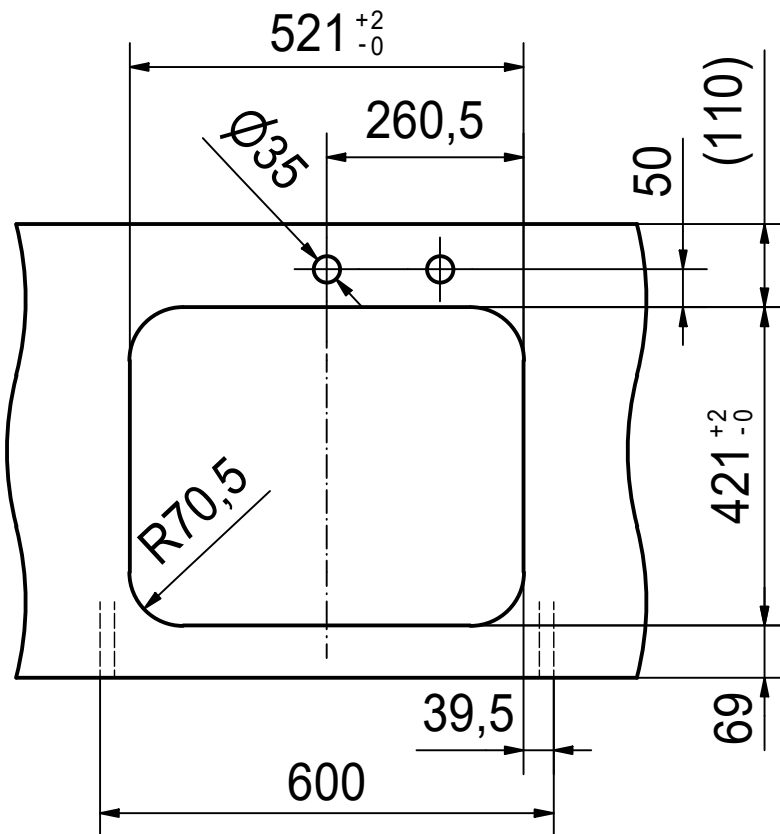

for flush fit only
541.4 x 441.4 x R80.7
(tolerance +0.5/0)

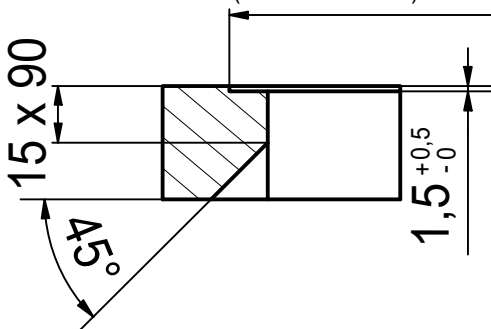

Drawing No.	20242539_01	Revision	-
Drawn Date	13.09.2022		
<small>These drawings and specifications are the property of Franke Technology and Trademark Ltd. and shall not be reproduced, copied or transferred to any third party without the prior written permission of Franke Technology and Trademark Ltd., Hergiswil, Switzerland</small>			



SRX 210-50 SI
installing document

Sheet	Sheets
3	6

CNC

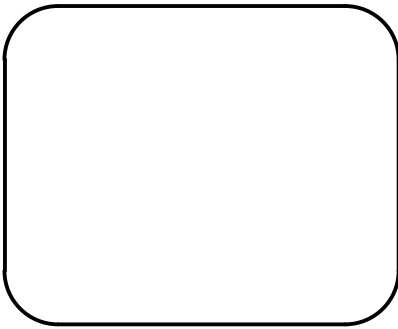

Drawing No.	20242539_01	Revision	-
Drawn Date	13.09.2022		
<small>These drawings and specifications are the property of Franke Technology and Trademark Ltd. and shall not be reproduced, copied or transferred to any third party without the prior written permission of Franke Technology and Trademark Ltd., Hergiswil, Switzerland</small>			



SRX 210-50 SI
installing document

Sheet	Sheets
4	6

DT

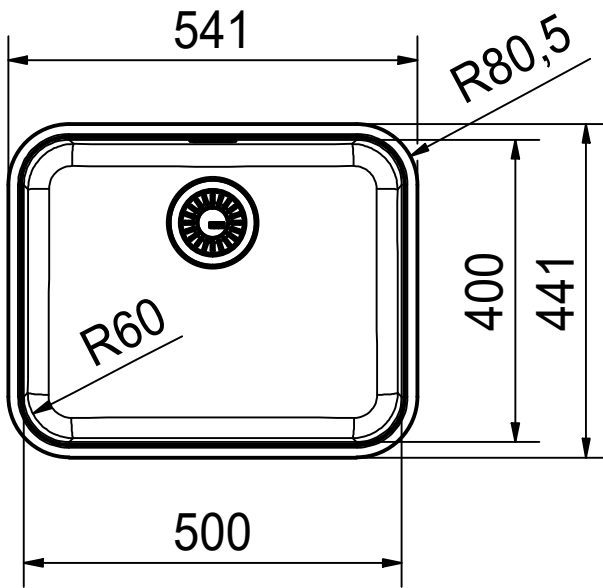

Drawing No.	20242539_01	Revision	-
Drawn Date	13.09.2022		
<small>These drawings and specifications are the property of Franke Technology and Trademark Ltd. and shall not be reproduced, copied or transferred to any third party without the prior written permission of Franke Technology and Trademark Ltd., Hergiswil, Switzerland</small>			



SRX 210-50 SI
installing document

Sheet	Sheets
5	6

ISO

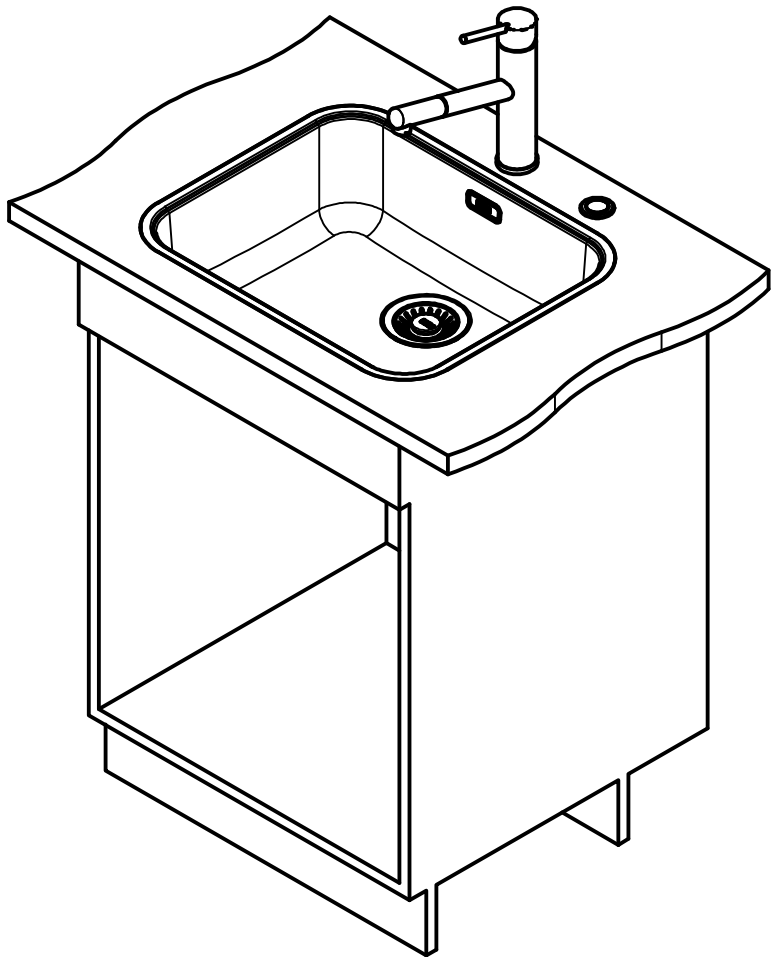

Drawing No.	20242539_01	Revision	-
Drawn Date	13.09.2022		
<small>These drawings and specifications are the property of Franke Technology and Trademark Ltd. and shall not be reproduced, copied or transferred to any third party without the prior written permission of Franke Technology and Trademark Ltd., Hergiswil, Switzerland</small>			



SRX 210-50 SI
installing document

Sheet	Sheets
6	6