

Mitoitusohje eri aukeamiskulmille ja oville

Ylösaukeavalle

75°

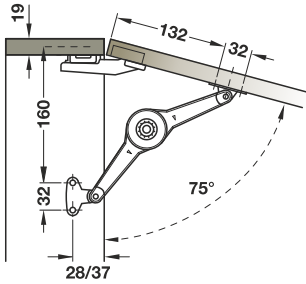

90°

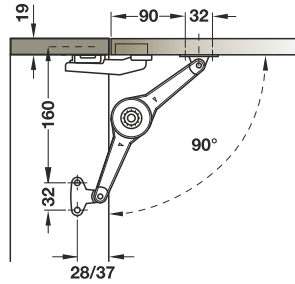

110°

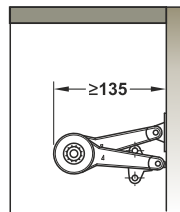
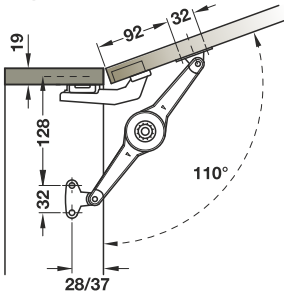

Alasaukeavalle

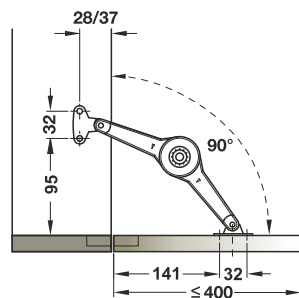
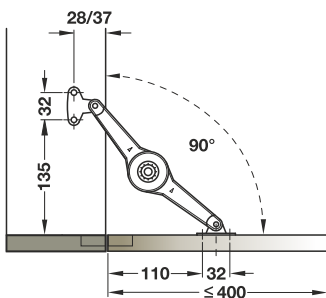

Vaatii erillisen salvan

Ilman erillistä salpaa

Käytä alasaukeavalle etulevyllä aina kahta aukipitolaitetta.

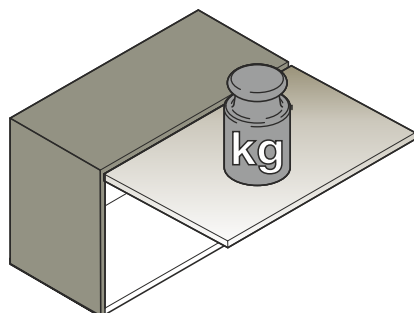
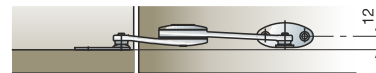

Vastuksen säätö nivelen keskeltä SW4 kuusiokoloavaimella



	Etulevyn korkeus mm	Etulevyn paino kg				
		Lukitsemaan		Hidastamaan		
		1 kpl	2 kpl	1 kpl	2 kpl	
Ylösaukeavalle						
75°	200	9.0	15.0	11.5	15.0	
	250	7.0	15.0	9.0	15.0	
	300	6.0	12.0	7.5	15.0	
	350	5.0	10.0	6.5	13.0	
	400	4.5	9.0	6.0	11.5	
	450	4.0	8.0	5.0	10.0	
90°	500	3.5	7.0	4.5	9.0	
	200 – 400 ks. kuten alasaukeavalle					
	450	3.5	6.5	4.5	8.5	
110°	500	3.0	6.0	4.0	7.5	
	200	6.0	12.0	8.0	15.0	
	250	5.0	9.5	6.0	12.0	
	300	4.0	8.0	5.0	10.0	
	350	3.5	7.0	4.0	9.0	
	400	3.0	6.0	4.0	7.5	
Alasaukeavalle	450	2.5	5.5	3.5	7.0	
	500	2.0	5.0	3.0	6.0	
	Alasaukeavalle					
	90°	200	7.5	15.0	9.5	15.0
		250	6.0	12.0	7.5	15.0
300		5.0	10.0	6.0	13.0	
350		4.0	8.5	5.5	11.0	
400	3.5	7.0	5.0	10.0		